

SPECIFICATION

Part No.: COB LED Neon Strip



Features

- High brightness.
- Long lifespan 50,000hours
- Energy-saving product
- Environment-friendly
- Certifications: CE & RoHS
- NO RF interference No Flicker, No Glare
- Easy to install and maintain
- Low in heat radiation and power consumption
- Uniform lighting effect without dot
- New Cutting Edge Technology
- IP grade: IP68

Dimensions:

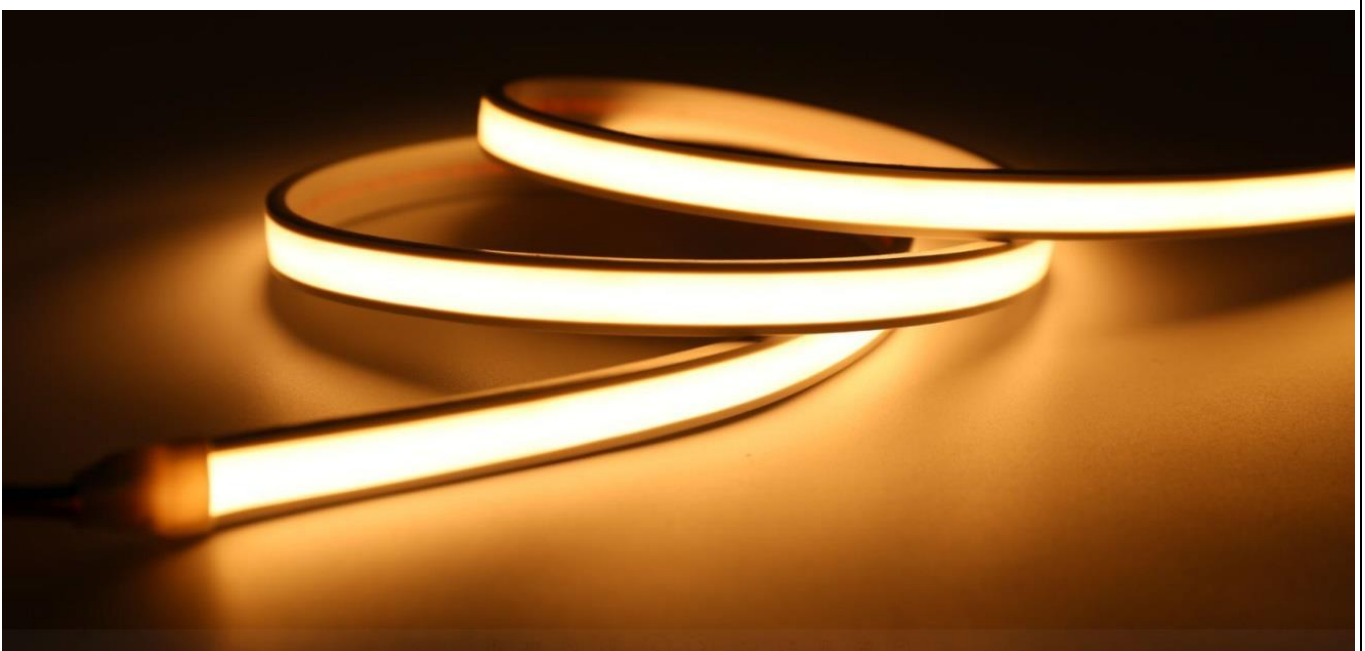
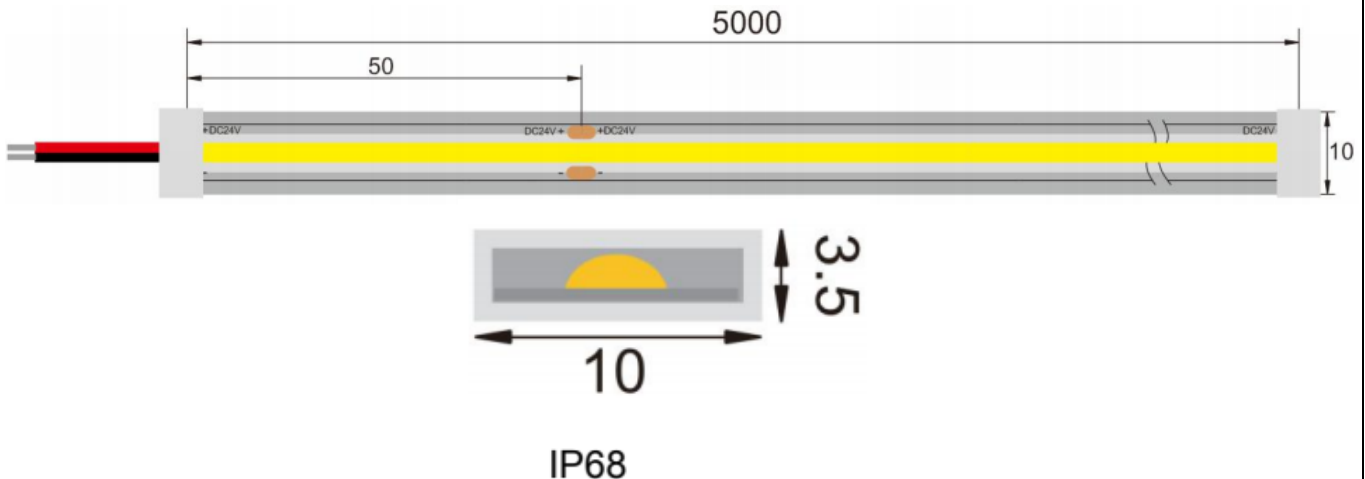

SPECIFICATION

Technical Specifications

Model	NSS-COB-480WN
Light Source	COB 480leds/M
Power	9w/M
Lumen(/w)	80-90lm/w
Lumen(/m)	700-800lm/m
Input Voltage(V)	DC24V
PCB Color	White, 8mm
Certification	CE & RoHS
Beam Angle	120°
CRI (Ra)	>90Ra
IP Grade	IP68
Color	R/G/B /W 2700-6000K
Warranty	5 years
Working Temp.	-25~+45°C
Storage Temp.	-30~+80°C
Package Length	5m/roll
Package Info.	300m/ctn, L680*W280*H290, 18.5kg/ctn

Connection



(PS: Strip positive connect to the driver positive,
Strip negative connect to driver negative)

SPECIFICATION

Installation

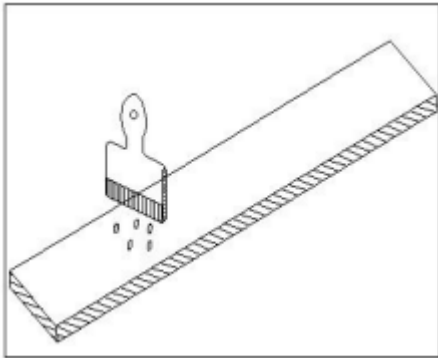

Clean the installation surface

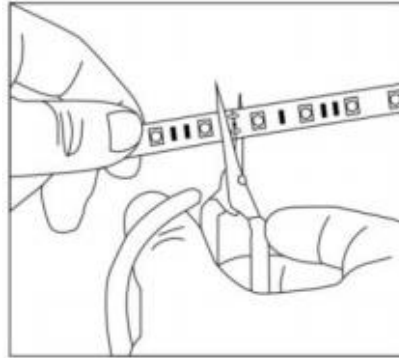

Measure the length you need, cut at the nearest scissor mark line.

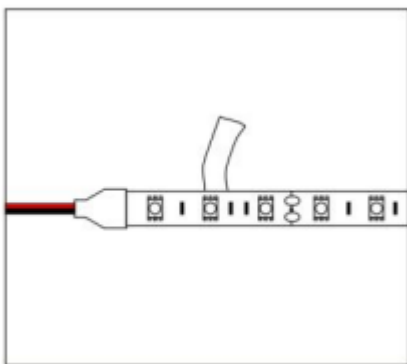

Do not release 3M paper by one time.
No press on the leds

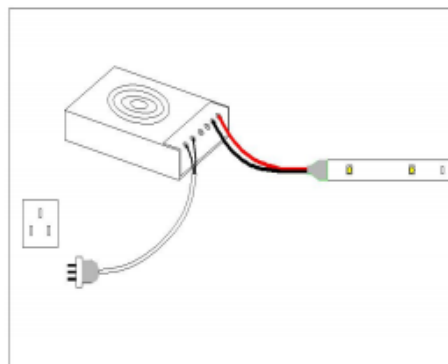

Connect the led strip wire to the driver output side
(Positive to positive, negative to negative.)

Package

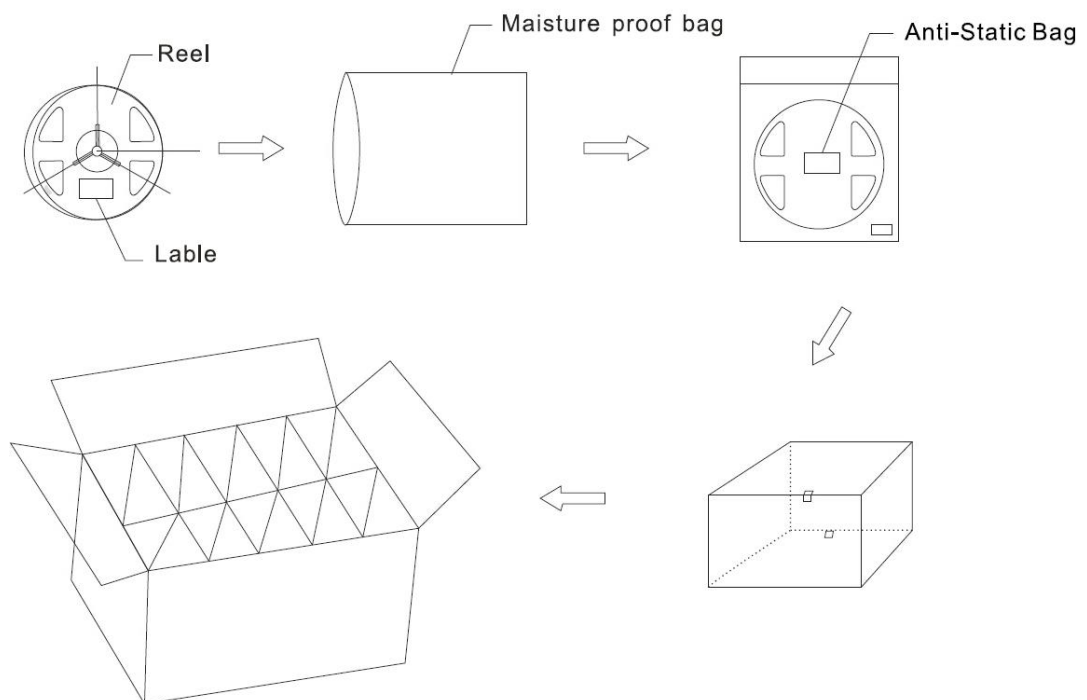

SPECIFICATION

Application

- Christmas/ Halloween show lighting
- For boat/barge decorations lighting
- Widely applicable as back lighting, cove lighting, decoration lighting, for home furniture, club, bar, hotel, commercial center
- Channel letter lighting using for stores, restaurants, bars
- Car interior and exterior lights
- Illumination lighting using walkway, canopy, stairway accent lighting, amusement park
- Outdoor illuminated signs and advertisements
- Other light sources