

NS108-2020

SPECIFICATION

EMBEDDED CONTROLLER TYPE LED

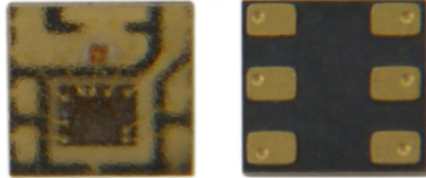

Declaration:

NEWSTAR LED as the original IC developer of NS107S NS108 series digital led, we reserve the right to pursue liability for fake and shoddy product on NS107S and NS108 series. So please kindly recognize NEWSTAR LED when you buy to get the best product, price as well as service. NEWSTAR LED will continuously develop the high quality product for you. NS107S series in DC12V and RGBW is under developing. your any comments on market demands will be much appreciated.

Document No.: SPC/ NS108 -2020

Model No.: NS108-2020

Description: 2.0X2.0X0.75mm Type 0.2Watt Power Embedded
Controller LED
LED

Rev. No.: 02

Date: 2019-12-06

正式规格书



Model: NS108-2020

1. Product Overview:

NS108-2020 is an embedded control type LED light source integrating control circuit and light-emitting circuit. Products containing a signal decoding module, data buffer, a built-in constant current circuit and RC oscillator; CMOS, low voltage, low power consumption; 66535 level grayscale PWM adjustment and 32 brightness adjustment; use the double output, Data and synchronization of the CLK signal, connected in series each wafer output action synchronization.

2. Main Application Field:

- Easy To Design
- Easy To Build
- Easy To Program

3. Description:

- LED internal integrated high quality external control line serial cascade constant current IC; 5V application; default on electric lights;
- The two-wire synchronous control.
- The three RGB output control, 16Bit (66535) color; 5Bit (32) to adjust the brightness;
- The three constant current drive, self detection function specific signal
- The maximum frequency of 40MHZ serial data input
- The double data transmission, built-in support uninterrupted oscillation PWM (27Khz) output, can maintain a static image.

4. Mechanical Dimensions:

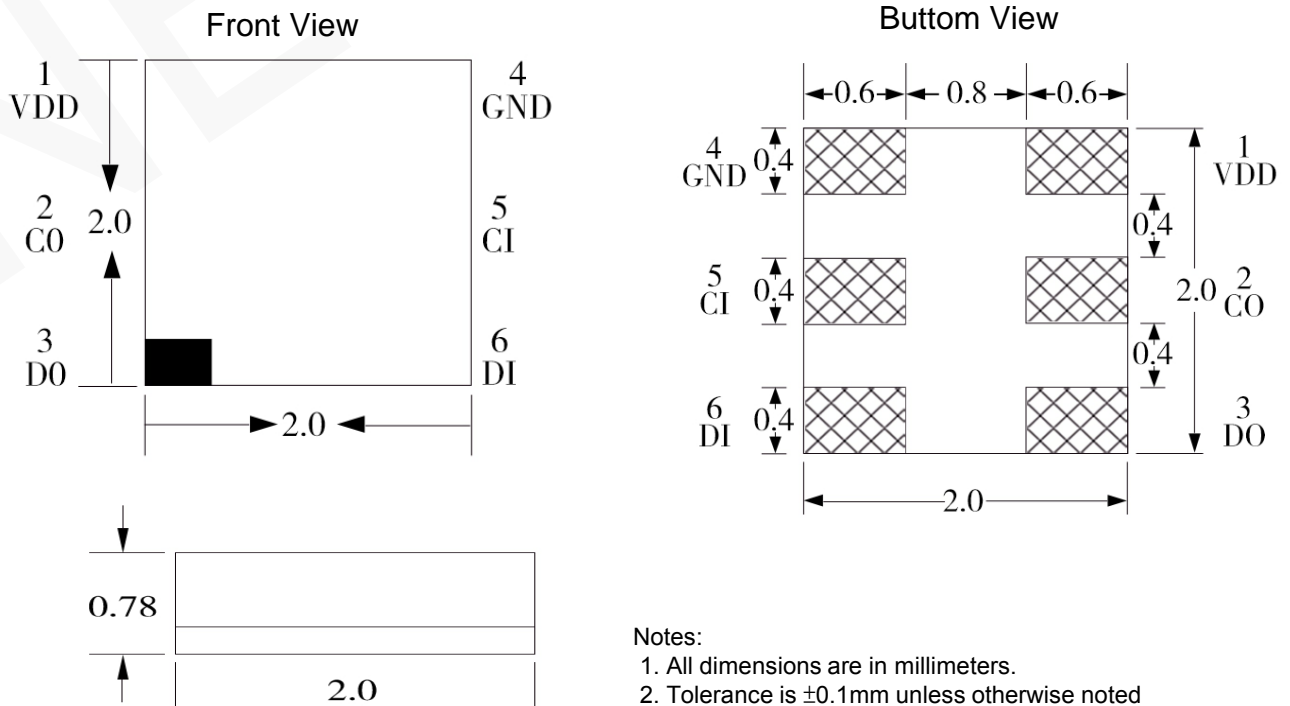

NEWSTAR LED CO., LIMITED

Address : 7F, Block A YuShan Industrial Park, Songbai Road, ShiYan Town, BaoAn | CN-51810 8 Shenzhen
 Tel: 0755-29405686 www.newstar-ledstrip.com info@newstarleds.com

■ PIN configuration

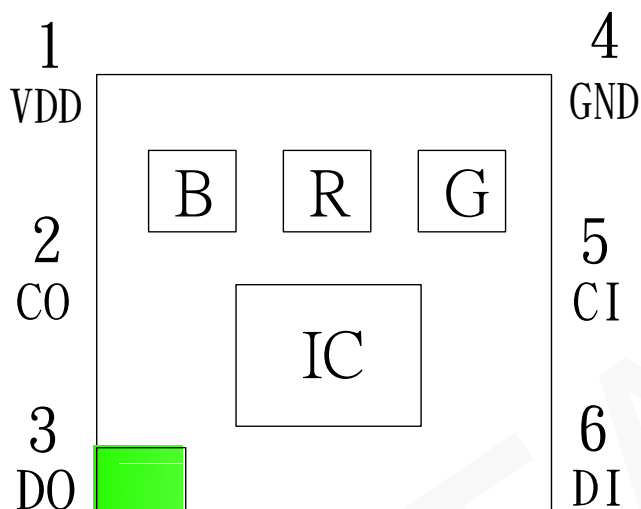

No.	Symbol	Function description
1	VDD	Supply Voltage
2	CO	Clock output
3	DO	Data output
4	GND	Ground
5	CI	Clock input
6	DI	Data input

■ Typical Product Characteristics (Ta = 25°C)

Characteristics	Symbol	Min.	Typ.	Max.	Unit	Test condition	
Forward Voltage	V_F	4.5		5.5	V	$I_F=18mA$	
Luminous Intensity	I_v	R	-	230	-	mcd	$I_F=18mA$
		G	-	320	-		
		B	-	80	-		
		W	270	530	-		
Dominant Wavelength	λ_d	R	615	-	630	nm	$I_F=18mA$
		G	520	-	530		
		B	460	-	475		
Color Coordinate	x		0.2257			$I_F=18mA$	
	y		0.2234				
View Angle	$2\theta_{1/2}$	-	120	-	deg	$I_F=18mA$	

NEWSTAR LED CO., LIMITED

Address : 7F, Block A YuShan Industrial Park, Songbai Road, ShiYan Town, BaoAn | CN-51810 8 Shenzhen
Tel: 0755-29405686 www.newstar-ledstrip.com info@newstarleds.com

■ Absolute Maximum Ratings (Ta=25°C, VSS=0V) :

Parameter	Symbol	Rating	Unit
IC Power Supply Voltage	VCC	+4.5~+5.5	V
LED voltage	Vled	3-7.5	V
Rate of data signal	FCLK	30	MHZ
The max led output Current	IOMAX	18	mA
Channel current deviation	DIO	Channel<3%,chip<5%	%
Power dissipation;	PD	<350	mW
Soldering Temperature*1	TSD	260	°C
Operating Temperature Range	-40°C to +85°C		
Storage Temperature Range	-40°C to +105°C		

Notes 1: The maximum of soldering time is 5 seconds in T_{SD}

■ Electrical/Optical Characteristics:

Characteristics	Symbol	Condition	Min.	Typ.	Max.	Unit
Supply voltage	V _{CC}			5.0	5.5	V
Input voltage	V _{IN}		-0.4		5	V
Rate of data signal	FCLK		0	20	-	MHZ
Input voltage level	V _{IH}	D _{IN} , SET	0.7 V _{CC}	-	-	V
	V _{IL}	D _{IN} , SET	-	-	0.3 V _{CC}	V
The clock high level width	T _{CLKH}		30	-	-	ns
The clock low level width	T _{CLKL}		30	-	-	ns
Data set up time	T _{SETUP}		10	-	-	ns
Data hold time	T _{HOLD}		5	-	-	ns

NEWSTAR LED CO., LIMITED

Address : 7F, Block A YuShan Industrial Park, Songbai Road, ShiYan Town, BaoAn | CN-51810 8 Shenzhen
 Tel: 0755-29405686 www.newstar-ledstrip.com info@newstarleds.com

■ The electrical parameters (unless otherwise specified, TA=-20 ~ +70 °C, VDD=4.5 ~ 5.5V, VSS=0V):

Characteristics	Symbol	Condition	Min.	Typ.	Max.	Unit
Transfer time	T _{THH}	CL=30pF,RL=1K Ω	-	-	15	ns
	T _{THL}		-	-	15	ns
Signal delay time	T _{pd}	CL=30pF,RL=1K Ω	-	-	12	ns
	T _{co}		-	-	12	ns
Signal rise and fall time	T _R	V _{cc} =5V	-	-	500	ns
	T _F		-	-	400	ns
The output minimum PWM opening width	T _{ONMIN}	I _{OUT} = 18mA	200	-	-	ns
The output signal maximum opening and closing time	T _{ON}	I _{OUT} = 18mA	-	--	80	ns
	T _{Off}		-	-	80	ns

■ Feature Descriptions:

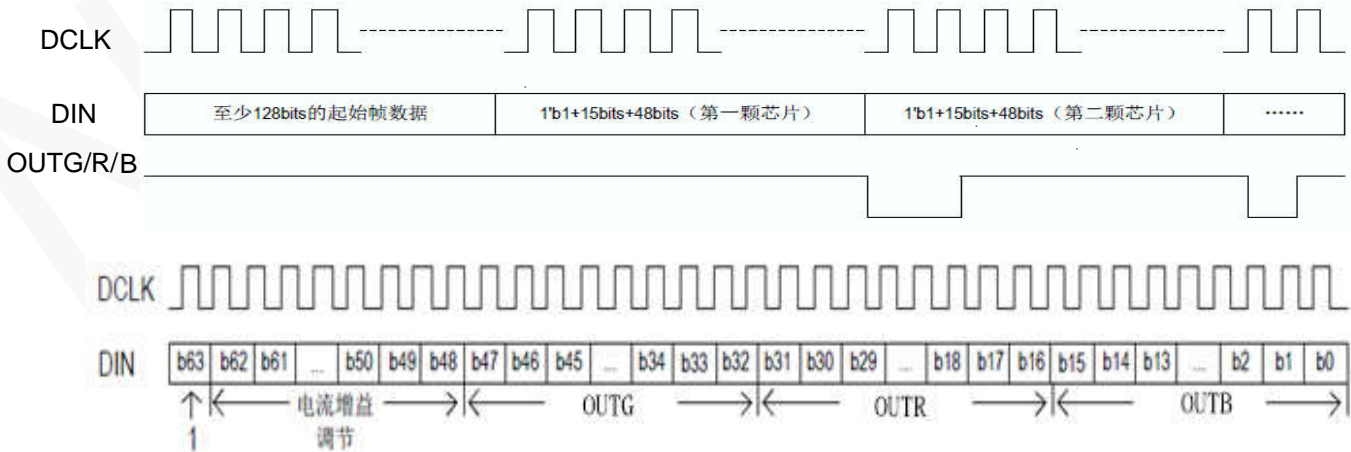

- (A) first into at least 128bits "0" as the starting frame, and then moved into the data frame, the starting frame and the data frame are high first move in, DCLK rising edge sampling data;
- (B) Each set of gray scale data is composed of 1bit start code + 15bits current gain adjustment value (red and green blue three ports each 5bits) + 48bits gray data (red, green and blue lights 16bits)
- (C) the first data frame is the corresponding distance from the end of the nearest LED driver chip;
- (D) After the completion of the gray data transmission, additional pulse corresponding to the number of chips need to add additional DCLK (that is, 512 chips in cascade, need to send additional 512 DCLK), DIN remains high, the new data that comes into effect;

■ Test Circuit and Precautions for Use

1. Typical application circuit

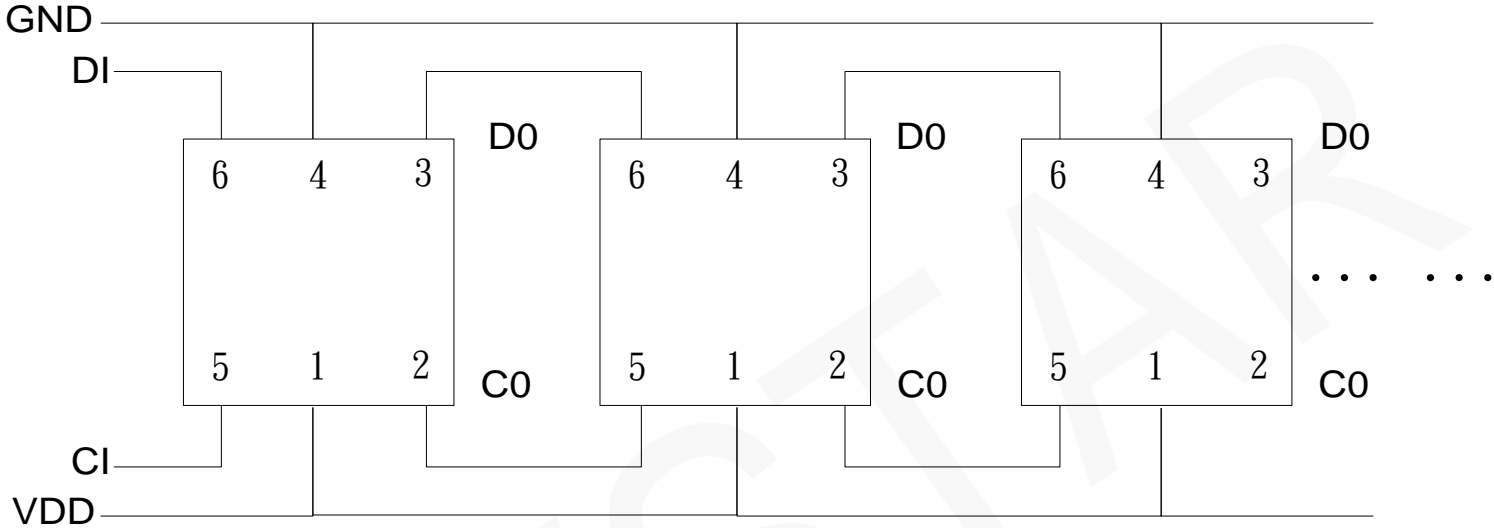

2. Precautions for Use

2.1. Over-current-proof

Customer must apply resistors for protection; otherwise slight voltage shift will cause big current change (Burn-out will happen).

2.2. Storage

1). To store the products is recommended with following conditions:

Humidity: 60% R.H. Max.

Temperature: 5°C~30°C (41°F~86°F)

2). Shelf life in sealed bag: 12 month at <5°C~30°C and <60% R.H.

2.3. Baking

No Matter the Package bag is open or not ,the LED must do dehumidification in the oven for 24-48 hours at 70°C before use and used within 2 hours, otherwise it need to be dehumidified again

1). 70±5°C X 24hrs and <5%RH, for reel

2). 150±3°C X 2hrs, for single LED

It shall be normal to see slight color fading of carrier (light yellow) after baking in process

NEWSTAR LED CO., LIMITED

Address : 7F, Block A YuShan Industrial Park, Songbai Road, ShiYan Town, BaoAn | CN-51810 8 Shenzhen
Tel: 0755-29405686 www.newstar-ledstrip.com info@newstarleds.com

■ Packaging Standard:

NS108-2020

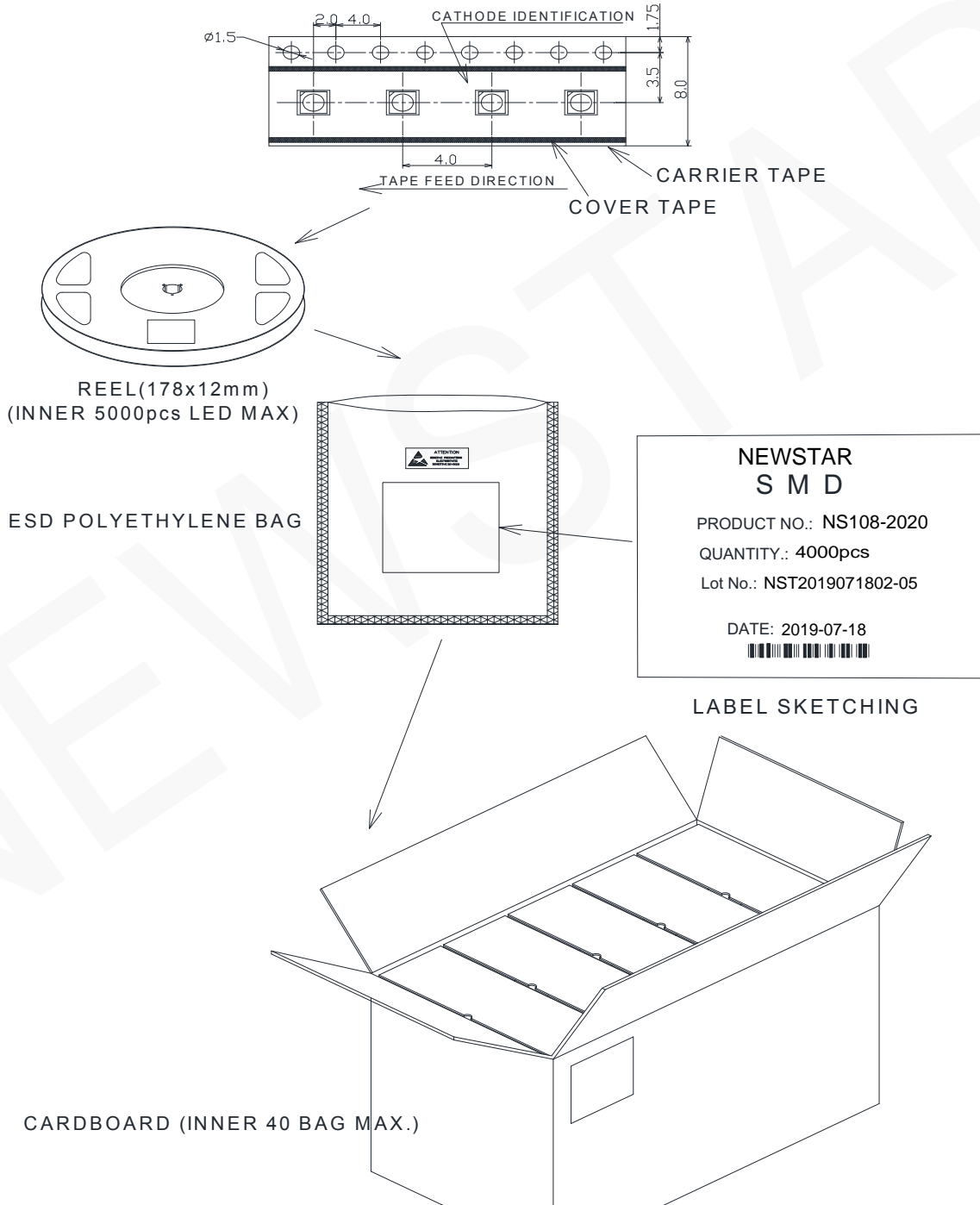

The reel pack is applied in SMD LED. The LEDs are packed in cardboard boxes after packaging in normal or anti-electrostatic bags. cardboard boxes will be used to protect the LEDs from mechanical shocks during transportation. The boxes are not water resistant and therefore must be kept away from water and moisture.

NEWSTAR LED CO., LIMITED

Address : 7F, Block A YuShan Industrial Park, Songbai Road, ShiYan Town, BaoAn | CN-51810 8 Shenzhen
 Tel: 0755-29405686 www.newstar-ledstrip.com info@newstarleds.com

■ Reliability Test :

NO.	Test item	Test Conditions	Reference	Criterion
1	Thermal Shock	100 ± 5° C ~ -40° C ± 5° C 30min~30min 300 cycles	MIL-STD-202G	0/22
2	High Temperature Storage	Ta= +100° C 1000hrs	JEITA ED-4701 200 201	0/22
3	Low Temperature Storage	Ta= -40° C 1000hrs	JEITA ED-4701 200 202	0/22
4	High Temperature High Humidity Storage	Ta=60° C RH=90% 1000hrs	JEITA ED-4701 100 103	0/22
5	Temperature Cycle	-55° C~25° C~100° C~25° C 30min~5min~30min~5min 100 cycles	JEITA ED-4701 100 105	0/22
6	Resistance to Soldering Heat	Tsld = 260° C, 10sec. 3 times	JEITA ED-4701 300 301	0/22
7	Room temp Life Test	25° C, IF: Typical current , 1000hrs	JESD22-A 108D	0/22

■ Criteria for Judging the Damage:

Item	Symbol	Test Condition	Limit	
			Min	Max
Luminous Intensity	IV	DC=5V, Typical current	Init. Value*0.7	---
Resistance to Soldering Heat	---	DC=5V, Typical current	No dead lights or obvious damage	

■ Reflow Soldering Characteristics

In testing, Newstar has found NS108 to be compatible with JEDEC J-STD-020C, using the parameters listed below. As a general guideline Newstar recommends that users follow the recommended soldering profile provided by the manufacturer of solder paste used.

Note that this general guideline is offered as a starting point and may require adjustment for certain PCB designs and Configurations of reflow soldering equipment.

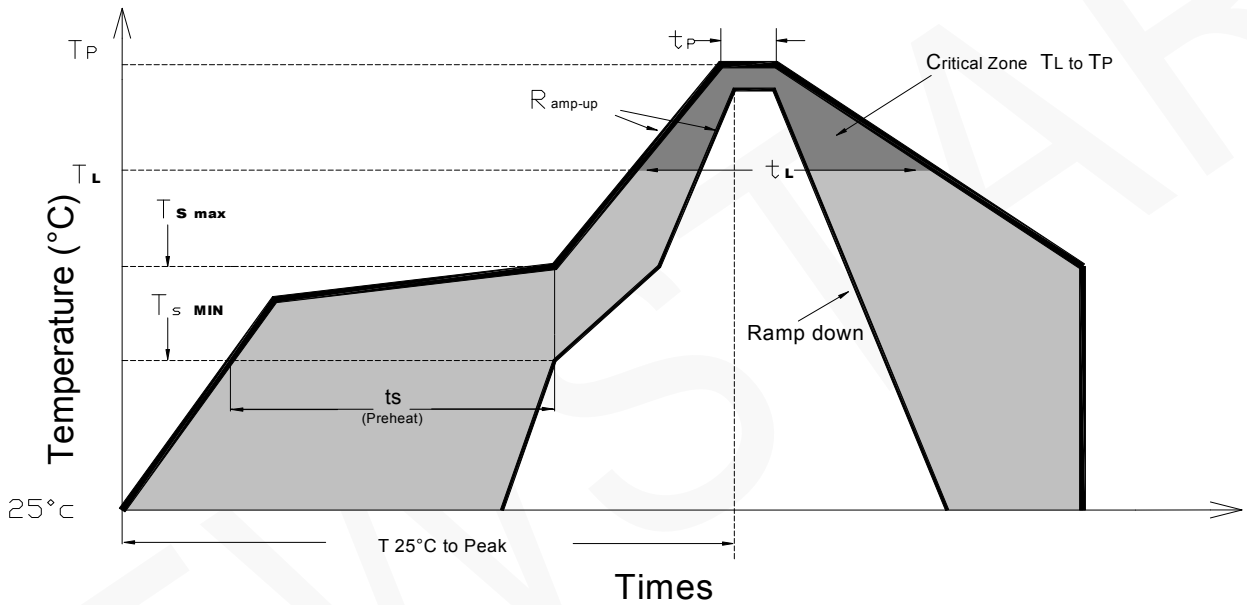

Profile Feature	Lead-Based Solder	Lead-Free Solder
Average Ramp-Up Rate (Ts _{max} to Tp)	3°C/second max.	3°C/second max.
Preheat: Temperature Min (Ts _{min})	100°C	150°C
Preheat: Temperature Min (Ts _{max})	150°C	200°C
Preheat: Time (ts _{min} to ts _{max})	60-120 seconds	60-180 seconds
Time Maintained Above: Temperature (TL)	183 °C	217 °C
Time Maintained Above: Time (tL)	60-150 seconds	60-150 seconds
Peak/Classification Temperature (Tp)	215 °C	240 °C
Time Within 5°C of Actual Peak Temperature (tp)	<10 seconds	<10 seconds
Ramp-Down Rate	6°C/second max.	6°C/second max.
Time 25 °C to Peak Temperature	<6 minutes max.	<6 minutes max.

Note: All temperatures refer to topside of the package, measured on the package body surface.

■ Heat Generation:

Thermal design of the end product is of paramount importance. Please consider the heat generation of the LED when making the system design. The coefficient of temperature increase per input electric power is affected by the thermal resistance of the circuit board and density of LED placement on the board, as well as components. It is necessary to avoid intense heat generation and operate within the maximum rating given in this specification. The operating current should be decided after considering the ambient maximum temperature of LEDs

The maximum working humidity of the product is not easy to exceed 40 ° C (≤ 40 ° C, refers to the product pin at the operating temperature)

■ Electrostatic Discharge & Surge Current :

Electrostatic discharge (ESD) or surge current (EOS) may damage LED.

Precautions such as ESD wrist strap, ESD shoe strap or antistatic gloves must be worn whenever handling of LED.

IC device signal input and output ports must be connected in series protection resistor to prevent surge or static shock port caused by product failure;

All devices, equipment and machinery must be properly grounded.

It is recommended to perform electrical test to screen out ESD failures at final inspection.

It is important to eliminate the possibility of surge current during circuitry design.

■ Moisture Proof Package

Cannot take any responsibility for any trouble that are caused by using the LEDs at conditions exceeding our specifications.

The LED light output is strong enough to injure human eyes. Precautions must be taken to prevent looking directly at the LEDs with unaided eyes for more than a few seconds.

The formal specification must be exchanged and signed by both parties before large volume purchase begins.

The appearance and specifications of the product may be modified for improvement without notice.

